

ALBANY SHED CO  
FLOOR PLAN: 606 RUTLAND 1.8 x 1.8m approx.

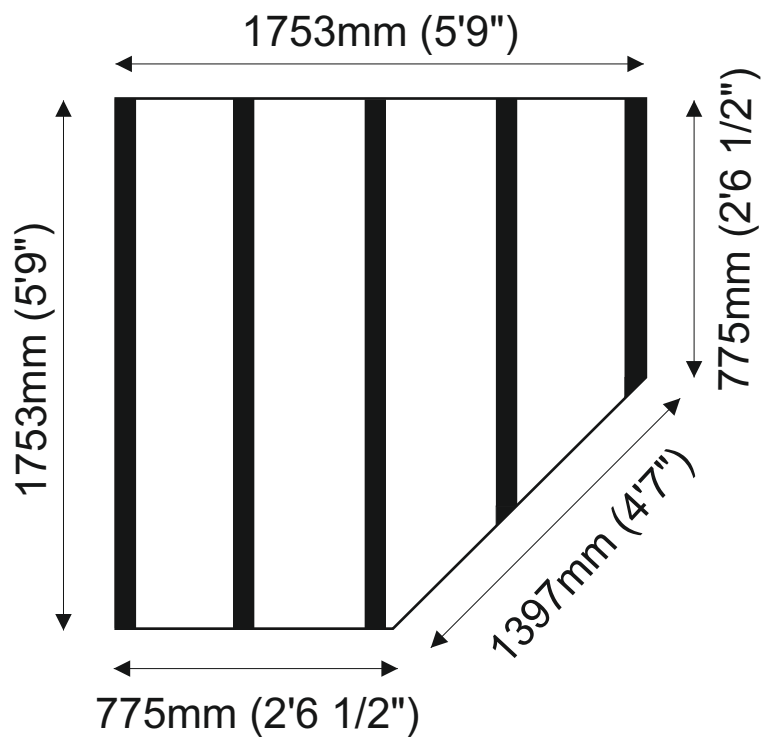

We reserve the right to alter design without prior notice