

ALBANY SHED CO
FLOOR PLAN: 707 RUTLAND 2.1 x 2.1m approx.

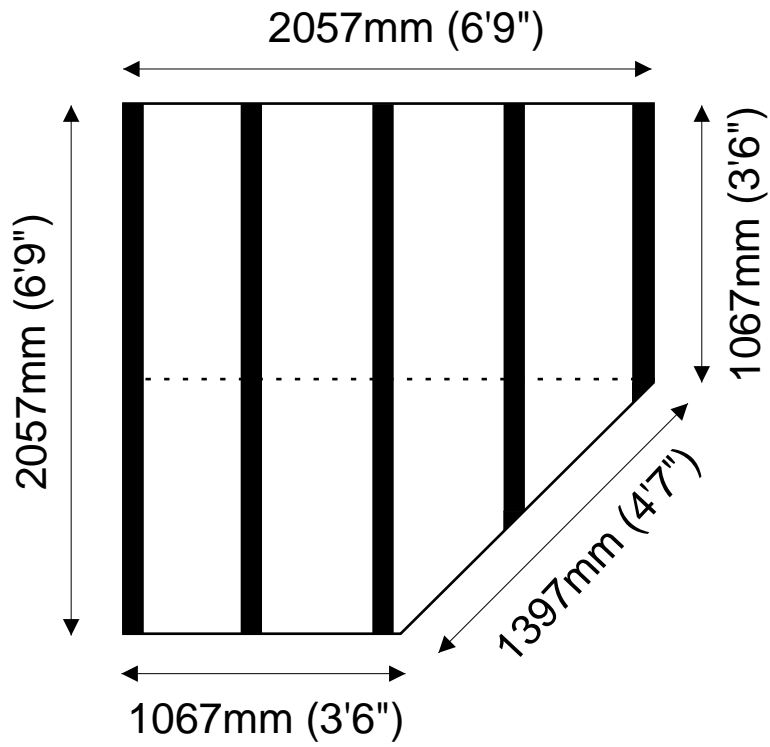

We reserve the right to alter design without prior notice