

ALBANY SHED CO
FLOOR PLAN: 808 LINCOLN 2.4 x 2.4m approx.

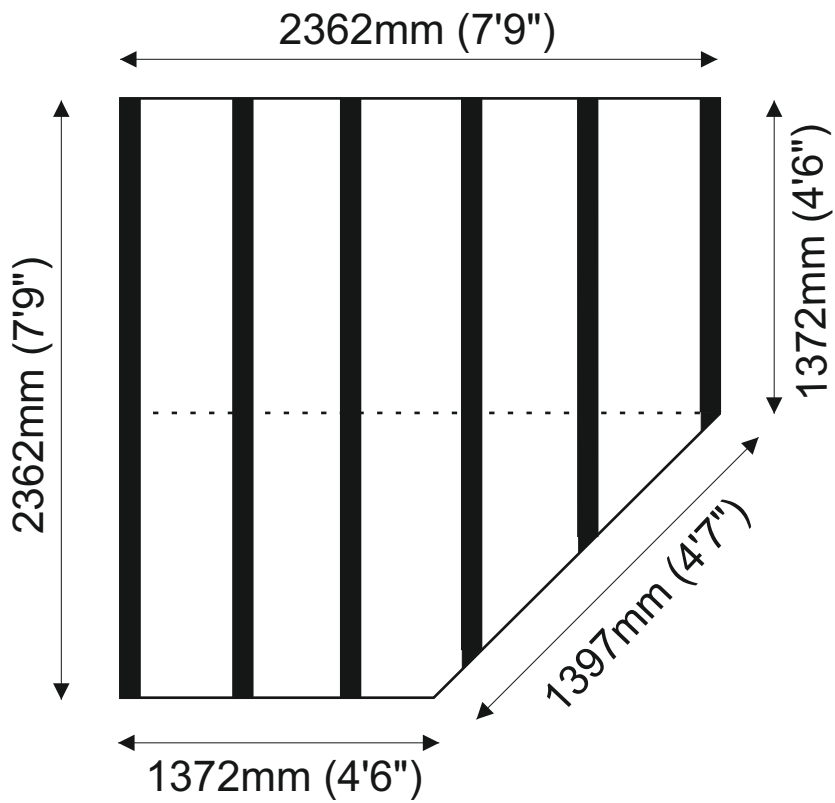

We reserve the right to alter design without prior notice